

Installation Instruction For NSC58 Series Solar Collector

	Description of NSC Series Solar Collector
	1 Manifold
	2 Anti-dust Ring
	3 Side Track
	4 Bottom Track
	5 Feet Holder
	6 Double Glass Vacuum Heat Pipe Tube
	7 Bolts & Nuts Lock Assembly

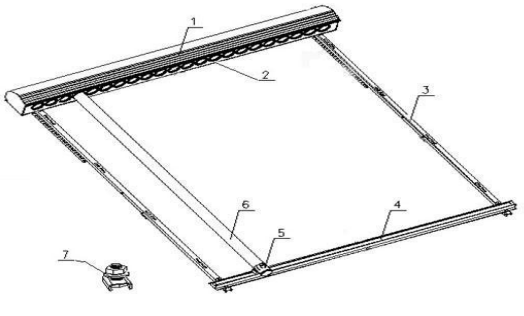
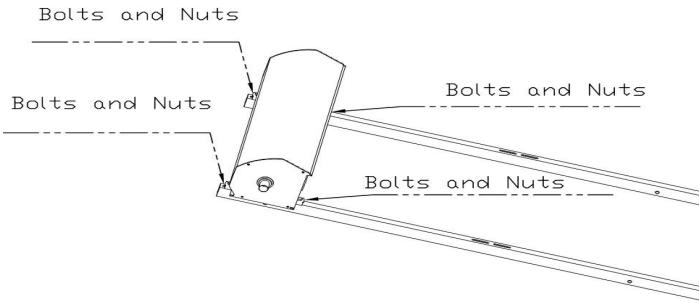

Bolts and Nuts

Bolts and Nuts

Bolts and Nuts

Bolts and Nuts

Step One:
Install the side track with the manifold

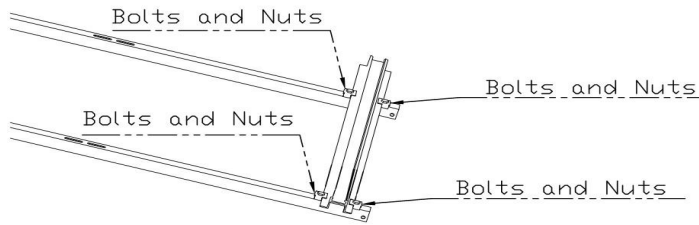

Bolts and Nuts

Bolts and Nuts

Bolts and Nuts

Bolts and Nuts

Step Two:
Install the side track with the bottom track

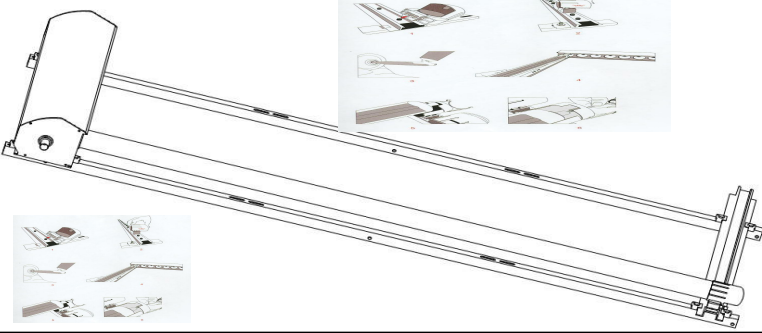



Bolts and Nuts





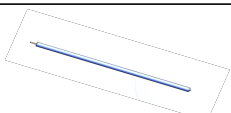

Bolts and Nuts

Bolts and Nuts

Step Three:
Install the tube
(Kindly note: please lubricate the tube condenser with thermal paste)

Packing List For NSC-58 Series Solar Collector

No.	Name	Photo	Specification
			NSC-58-30
1	Tube		30
2	Manifold		1

3	Anti-dust Ring		30
4	Side Track		3
5	Feet Holder		30
6	Bottom Track		1
7	Bolts & Nuts		12
8	Thermal Paste		1